



# Accent<sup>®</sup>800



## User's Guide

Accent<sup>®</sup> 800 Dedicated and Non-Dedicated Devices with NuVoice<sup>®</sup> Software

Model ACN800-40



18664  
Version 3.00

## Copyright and Trademark Information

© 2017-2023 PRC-Salttillo. Non-commercial reprint rights for clinical or personal use granted with inclusion of copyright notice. Commercial use prohibited; may not be used for resale. Contact PRC-Salttillo for questions regarding permissible uses.

AAC Coaching Corner™, AAC Language Lab®, AAC Learning Journey™, Accent®, AeroSwitch®, AeroText™, ChatEditor™, ChatFusion™, ChatPoint™, ChatSMS®, ChatWrap®, CoreScanner™, Dialogue®, Empower®, Engage®, Essence®, Freedom Switch™, iSharePRC®, LAMP™, LAMP Words for Life®, Look®, Minspeak®, NovaChat®, NuEye®, NuPoint®, NuVoice®, PASS™, PRiO®, Realize Language™, Semantic Compaction®, Timocco-on-Accent™, TouchChat®, UNIDAD®, Unity®, VersaChat™, Via® and VocabPC™ are trademarks of PRC-Salttillo.

The *Bluetooth*® word mark and logos are registered trademarks owned by the Bluetooth SIG, Inc. and any use of such marks by PRC-Salttillo is under license.

CAVIWIPES™ is a trademark of Metrex Research LLC.

Intel®, Intel Atom®, Intel® Core™, and Intel® Xeon® are trademarks of Intel Corporation or its subsidiaries.

Microsoft® and Windows® are either registered trademarks or trademarks of Microsoft Corporation in the United States and/or other countries.

Velcro® is a registered trademark of Velcro BVBA.



Wi-Fi® is a registered trademark of Wi-Fi Alliance.

Windex® is a registered trademark of S. C. Johnson & Son, Inc.

WordPower® is a trademark of Inman Innovations, Inc. © 2001-2022; All rights reserved. Used with permission.

Other trademarks are the property of their respective owners.

## Contact Information

| Manufacturer   | EU Authorised Representative  | EU Importer   |
|--|---|---|
|   |    |    |
| <b>Prentke Romich Company</b><br>1022 Heyl Rd<br>Wooster, OH 44691<br>USA<br>Tel.: +1 330 262-1984 · +1 800 262-1984<br>Fax: +1 330 262-4829<br>Email: <a href="mailto:info@prentrom.com">info@prentrom.com</a><br>Web: <a href="http://www.prc-salttillo.com/">www.prc-salttillo.com/</a> | <b>Prentke Romich GmbH</b><br>Karthäuserstr. 3<br>D-34117 Kassel<br>Germany<br>Tel.: +49 (0) 561 7 85 59-0<br>Fax: +49 (0) 561 7 85 59-29<br>Email: <a href="mailto:info@prentke-romich.de">info@prentke-romich.de</a><br>Web: <a href="http://www.prentke-romich.de/">www.prentke-romich.de/</a> | <b>Prentke Romich GmbH</b><br>Karthäuserstr. 3<br>D-34117 Kassel<br>Germany<br>Tel.: +49 (0) 561 7 85 59-0<br>Fax: +49 (0) 561 7 85 59-29<br>Email: <a href="mailto:info@prentke-romich.de">info@prentke-romich.de</a><br>Web: <a href="http://www.prentke-romich.de/">www.prentke-romich.de/</a> |

| UK Responsible Person and Importer   | Authorised Representative in Australia  |
|--|---|
|   |   |
| <b>Liberator Ltd</b><br>"Whitegates", 25-27 High Street<br>Swinstead, Lincolnshire NG33 4PA<br>UK<br>Tel.: +44 (0) 1733 370 470<br>Fax: +44 (0) 1476 552 473<br>Email: <a href="mailto:info@liberator.co.uk">info@liberator.co.uk</a><br>Web: <a href="http://www.liberator.co.uk/">www.liberator.co.uk/</a> | <b>Liberator Pty Ltd</b><br>Level 4, 2-4 Holden Street, Ashfield,<br>NSW, 2131<br>Australia<br>Tel: +61 (0) 8 8211 7766<br>Fax: +61 (0) 8 8211 7733<br>Email: <a href="mailto:info@liberator.net.au">info@liberator.net.au</a><br>Web: <a href="http://www.liberator.net.au/">www.liberator.net.au/</a> |

## Technical Support

To report unexpected operation of the device or an unexpected event related to the device, please contact PRC technical support by phone at 1-800-262-1990 or by email at [service@prentrom.com](mailto:service@prentrom.com).

## Document Version / Software Version

18664v3.00 · 12/04/2022 / NuVoice software version 2.27

Applies to model ACN800-40; Accent 800-40 dedicated and non-dedicated devices with NuVoice software

To view or download the latest version of this manual, please visit <https://www.prentrom.com/support/accent>.

For information on using an Accent 800 device with Empower software, view or download the *Accent 800 User's Guide for Empower* from <https://www.prentrom.com/support/devices/accent-with-empower>.

## End User Licensing Agreement

You have acquired a PRC device which includes software licensed by PRC-Salttillo from Microsoft Licensing Inc. or its affiliates ("MS"). Those installed software products of MS origin, as well as associated media, printed materials and "online" or electronic documentation (software) are protected by international intellectual property laws and treaties.

IF YOU DO NOT AGREE TO THIS END USER LICENSE AGREEMENT (EULA), DO NOT USE THE DEVICE OR COPY THE SOFTWARE. INSTEAD, PROMPTLY CONTACT PRC-SALTILLO FOR INSTRUCTIONS. ON RETURN OF THE UNUSED DEVICE(S) FOR A REFUND. **ANY USE OF THE SOFTWARE, INCLUDING BUT NOT LIMITED TO USE ON THE DEVICE, WILL CONSTITUTE YOUR AGREEMENT TO THIS EULA (OR RATIFICATION OF ANY PREVIOUS CONSENT).**

### GRANT OF SOFTWARE LICENSE

This EULA grants you the following license:

- You may use the SOFTWARE only on your PRC device.
- **NOT FAULT TOLERANT.** THE SOFTWARE IS NOT FAULT TOLERANT. PRC-SALTILLO HAS INDEPENDENTLY DETERMINED HOW TO USE THE SOFTWARE AND MS HAS RELIED UPON PRC-SALTILLO TO CONDUCT SUFFICIENT TESTING TO DETERMINE THAT THE SOFTWARE IS SUITABLE FOR SUCH USE.
- **NO WARRANTIES FOR THE SOFTWARE.** THE SOFTWARE is provided "AS IS" and with all faults. THE ENTIRE RISK AS TO SATISFACTORY QUALITY, PERFORMANCE, ACCURACY, AND EFFORT (INCLUDING LACK OF NEGLIGENCE) IS WITH YOU. ALSO THERE IS NO WARRANTY AGAINST INTERFERENCE WITH YOUR ENJOYMENT OF THE SOFTWARE OR AGAINST INFRINGEMENT. IF YOU HAVE RECEIVED ANY WARRANTIES REGARDING THE DEVICE OR SOFTWARE, THOSE WARRANTIES DO NOT ORIGINATE FROM, AND ARE NOT BINDING ON, MS.
- **Note on Java Support.** The SOFTWARE may contain support for programs written in Java. Java technology is not fault tolerant and is not designed, manufactured, or intended for use or resale as online control equipment in hazardous environments requiring fail-safe performance, such as in the operation of nuclear facilities, aircraft navigation or communication systems, air traffic control, direct life support machines, or weapons systems, in which the failure of Java technology could lead directly to death, personal injury or severe physical or environmental damage. Sun Microsystems, Inc. has contractually obligated MS to make this disclaimer.
- **No Liability for Certain damages.** EXCEPT AS PROHIBITED BY LAW, MS SHALL HAVE NO LIABILITY FOR ANY INDIRECT, SPECIAL CONSEQUENTIAL OR INCIDENTAL DAMAGES ARISING FROM OR IN CONNECTION WITH THE USE OR PERFORMANCE OF THE SOFTWARE. THIS LIMITATION SHALL APPLY EVEN IF ANY REMEDY FAILS OF ITS ESSENTIAL PURPOSE. IN NO EVENT SHALL MS BE LIABLE FOR ANY AMOUNT IN EXCESS OF U.S. TWO HUNDRED FIFTY DOLLARS (U.S. \$250.00).
- **Limitations on Reverse Engineering, Decompilation and Disassembly.** You may not reverse engineer, decompile, or disassemble the SOFTWARE, except and only to the extent that such activity is expressly permitted by applicable law notwithstanding this limitation.
- **SOFTWARE TRANSFER ALLOWED BUT WITH RESTRICTIONS.** You may permanently transfer rights under this EULA only as part of a permanent sale or transfer of the Device, and only if the recipient agrees to this EULA. If the SOFTWARE is an upgrade, any transfer must also include all prior versions of SOFTWARE.
- **EXPORT RESTRICTIONS.** You acknowledge that SOFTWARE is subject to U.S. export jurisdiction. You agree to comply with all applicable international and national laws that apply to the SOFTWARE, including U.S. Export Administration Regulations, as well as end-user, end-use and destination restrictions issued by U.S. and other governments. For additional information see <http://www.microsoft.com/exporting/>.

## Contents

The Accent® 800 is a speech-generating device that offers user-friendly features to make speaking fast and easy for individuals with severe speech impairments. This manual describes how to use and maintain your device.

|  |           |
|--|-----------|
| <b>Safety Information</b> .....                                  | <b>5</b>  |
| <b>A Quick Look at Device Features</b> .....                     | <b>7</b>  |
| <b>Turning on the Device</b> .....                               | <b>10</b> |
| <b>Using the Touchscreen</b> .....                               | <b>10</b> |
| <b>Charging the Battery</b> .....                                | <b>10</b> |
| <b>Cleaning and Disinfecting the Device</b> .....                | <b>11</b> |
| Routine Cleaning and Disinfecting .....                          | 11        |
| Disinfecting a Device and Accessories for Multiple Users .....   | 12        |
| <b>Positioning or Removing the Stand</b> .....                   | <b>13</b> |
| Positioning the Stand .....                                      | 13        |
| Removing the Stand .....   | 14        |
| <b>Removing or Reattaching the Handle</b> .....                  | <b>15</b> |
| <b>Attaching the Top Port Cover</b> .....                        | <b>16</b> |
| <b>Mounting the IR Reflector on a Non-Dedicated Device</b> ..... | <b>17</b> |
| <b>Applying a Screen Protector</b> .....                         | <b>19</b> |
| <b>Removing or Replacing the Device Frame</b> .....              | <b>20</b> |
| Removing the Frame .....   | 20        |
| Attaching the New Frame .....                                    | 21        |
| Attaching the Frame More Securely .....                          | 21        |
| <b>Attaching, Raising, and Removing a Keypad</b> .....           | <b>22</b> |
| Attaching the Keypad.....  | 22        |
| Raising the Keypad.....  | 23        |
| Removing the Keypad .....  | 23        |

|   |           |
|---|-----------|
| <b>Attaching or Removing a TouchGuide</b> .....             | <b>24</b> |
| Attaching the TouchGuide .....                              | 24        |
| Removing the TouchGuide.....                                | 25        |
| <b>Attaching a Carry Strap</b> .....                        | <b>26</b> |
| <b>Attaching a Strap Handle</b> .....                       | <b>28</b> |
| <b>Attaching a QRM Mounting Plate</b> .....                 | <b>29</b> |
| <b>Mounting a NuPoint Module</b> .....                      | <b>30</b> |
| <b>Getting Started with the NuVoice Software</b> .....      | <b>31</b> |
| Putting the Device to Sleep/Waking the Device .....         | 31        |
| Restarting the Device .....                                 | 31        |
| Powering Off the Device .....                               | 31        |
| Selecting a Vocabulary .....                                | 32        |
| Using the Exploration Wizard.....                           | 34        |
| Accessing the Toolbox.....                                  | 34        |
| Changing the Vocabulary .....                               | 34        |
| Replacing the Vocabulary.....                               | 34        |
| Changing the Voice .....                                    | 35        |
| Turning Speech On or Off.....                               | 35        |
| Adjusting the Volume.....                                   | 35        |
| Correcting the Pronunciation of a Word.....                 | 35        |
| Changing the Access Method.....                             | 35        |
| Accessing the Setup Key.....                                | 36        |
| Customizing a Key .....                                     | 36        |
| Taking Your Own Photo to Use on a Key.....                  | 36        |
| Disabling and Enabling the Toolbox .....                    | 37        |
| Backing up Your Vocabularies .....                          | 37        |
| Updating the NuVoice Software via a Wi-Fi® Connection ..... | 38        |
| Updating the NuVoice Software via USB Flash Drive .....     | 38        |
| <b>Finding Additional Information</b> .....                 | <b>38</b> |
| <b>Appendix: Compliance Information</b> .....               | <b>39</b> |

# Safety Information

## Emergencies

- ⚠ This device is not intended to be an emergency call device or sole communication aid.

## Cleaning, Maintaining, and Servicing

- ⚠ Do not attempt to service or maintain the device while it is in use. Disconnect the charger and turn off the device before cleaning or disinfecting the device.
- ⚠ If your device or an accessory is damaged, call Service for assistance. Do not attempt to make repairs yourself.

## Accessories

- ⚠ Do not use accessories, detachable parts, or materials not described in this manual.
- ⚠ Do not use accessories, detachable parts, or materials in any other way than described in this manual.

## Mounting and Positioning

- ⚠ Any mounts used should be fitted by a qualified person. Failure to install the mounting system according to the manufacturer's instructions may result in an injury to the user. Be certain that the user's view is not obstructed by the mounting.
- ⚠ Analysis of positioning by a qualified person is required to prevent repetitive stress injuries to the user.

## Vision and Hearing

- ⚠ The communication partner should ensure that the user takes frequent breaks to avoid eye strain.
- ⚠ Consult your vision care provider about device positioning considerations for the user.
- ⚠ Excessive volume or sound pressure level when using earphones or headphones can cause hearing loss over extended periods of time. Set the volume at a low level and increase it only enough that you can hear comfortably.

## Ports and Connectors

- ⚠ Keep the device ports and mating cable connectors clean so that they make the best possible contact and are able to maximize the service life of your device. Dirty cable connectors will transfer the contaminate to the mating connector on the device and may degrade performance.
- ⚠ If your device has been exposed to water, each USB port must be completely dry before a USB cable is inserted into it. To remove moisture from the USB ports, shake the device several times with each USB port facing downward, and then use a microfiber cloth to wipe the device dry. You should then check the USB port area again. If moisture is still visible in any USB port, repeat the shaking and drying procedure.
- ⚠ Do not try to force a connector into a port. Be sure you are inserting the connector into the correct port and that you have the connector turned so that it matches the orientation of the port.

## Small Parts, Cords, Cables, and Straps

- ⚠ Cords, cables, and straps are potential entanglement or strangulation hazards. Please consider this prior to placing these items with device users.
- ⚠ On a regular basis, visually inspect cables, cords, and connectors for damage or wear, especially where they are subject to extra stress. Cables and cords can become frayed or damaged from heavy use or with age. For example, a frayed cable could cause a battery charger/power adapter to short-circuit, posing a hazard to the user. If any cable, cord, or connector is damaged or worn, call Service for a replacement.
- ⚠ When unplugging a cable or cord, grasp the connector instead of the cable or cord itself to avoid damage or wear.
- ⚠ Always use cables, whether for charging or transferring vocabulary files, according to the instructions in this manual.
- ⚠ Small parts could present a choking or other hazard.
- ⚠ If the stand is removed, it becomes a potential hazard for poking an eye. Store it in a safe location.
- ⚠ The user could pinch a finger when closing the stand.
- ⚠ The stylus is a potential hazard for poking an eye.

## Screen

- ⚠ Do not use the device if the screen is cracked or broken.

## Interference

- ⚠ When operating this device in a medical environment, do not use with any product that is not medically approved. Follow all rules for appropriate wireless device use.
- ⚠ Do not use this device close to sources of RF/RFID radiation or you may encounter interference. Move away, if possible, from the source of the interference.

## Water

- ⚠ If your device has been exposed to water, each USB port must be completely dry before a USB cable is inserted into it. To remove moisture from the USB ports, shake the device several times with each USB port facing downward, and then use a microfiber cloth to wipe the device dry. You should then check the USB port area again. If moisture is still visible in any USB port, repeat the shaking and drying procedure.
- ⚠ Your device is intended for use in normal communication situations. It is not waterproof. Do not spray or splash liquid directly on the device and use extreme caution when using it around water. As with most electronic devices, you should never use the device when you are actually in the water (for example, a pool or bath).

## Batteries and Charging

- ⚠ Use only the battery charger provided with your device.
- ⚠ Do not place the device where it is difficult to operate or difficult to disconnect from the charger.
- ⚠ Always follow the instructions in this manual when charging your device.
- ⚠ Do not insert any object into the charging port. This can result in damage to the port.
- ⚠ To avoid electric shock and damage to your device, do not charge the device while it is wet or in an area where it could get wet. Do not handle the device, charger, or cords with wet hands.
- ⚠ Locate the device in a safe, dry location while charging. Do not charge the device outdoors.
- ⚠ Keep the charger away from water and do not allow water or any other liquid to be spilled on it.
- ⚠ If the charger or charger cord is damaged, call Service for a replacement.

## Heat

- ⚠ Do not place the device in an appliance such as a microwave or oven, near an open flame, or on or near a source of heat such as a stove or heater.
- ⚠ Do not leave the device in a hot vehicle for a prolonged period.

## Oxygen-Rich Environment

- ⚠ Do not take the device into an oxygen-rich environment (operating room, oxygen tent, etc.).

## Touching the Surface

- ⚠ While the device is charging, touching the surface of the device with broken skin may aggravate a wound.
- ⚠ While the device is charging, infants or high-risk groups should not touch the surface of the device if there is a chance of burning the skin.

## Implantable Medical Devices

A minimum separation of six (6) inches should be maintained between a handheld wireless mobile device and an implantable medical device, such as a pacemaker, implantable cardioverter defibrillator, vagus nerve stimulator, shunt, or stent, to avoid potential magnetic interference with the medical device. Persons who have such devices:

- Should ALWAYS keep the mobile device a minimum of six (6) inches from their implantable medical device;
- Should not carry the mobile device in a breast pocket;
- Should move the mobile device away from themselves immediately if there is any reason to suspect that it is interfering with the implantable medical device;
- Should read and follow the directions from the manufacturer of the implantable medical device. If you have any questions about using your wireless mobile device with an implantable medical device, *consult your health care provider.*

# A Quick Look at Device Features

## Front View



|   |                     |    |                      |
|---|---------------------|----|----------------------|
| 1 | Handle              | 8  | Volume button        |
| 2 | Microphone          | 9  | Microphone           |
| 3 | Front camera        | 10 | Battery/charging LED |
| 4 | Light sensor        | 11 | Power LED            |
| 5 | Camera indicator    | 12 | Display screen       |
| 6 | Power button        | 13 | Tools button         |
| 7 | Carry strap holders |    |                      |

## Back View



|   |  |   |   |
|---|--|---|---|
| 1 | Stand (fully open position)  | 4 | Attachment point for handle or NuPoint head tracking module |
| 2 | Handle   | 5 | QRM mounting plate location                                 |
| 3 | Mini USB connector for NuPoint® head tracking module (accessible when handle is removed) | 6 | Microphone (Bluetooth phone calls)                          |



## Left Side View



|   |                           |   |                           |
|---|---------------------------|---|---------------------------|
| 1 | External access mini port | 4 | USB 3.0 port <sup>2</sup> |
| 2 | USB 2.0 port <sup>1</sup> | 5 | USB-C port                |
| 3 | USB 2.0 port <sup>1</sup> |   |                           |

<sup>1</sup> The USB 2.0 ports support USB 2.0 and USB 1.0 accessories.

<sup>2</sup> The USB 3.0 port supports USB 3.0, USB 2.0, and USB 1.0 accessories.

## Right Side View

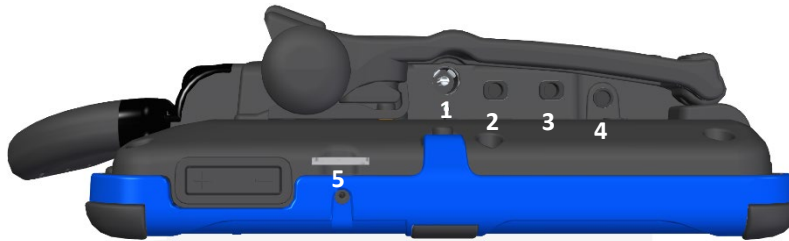

|   |                 |   |                   |
|---|-----------------|---|-------------------|
| 1 | Charging port   | 4 | Headphone jack    |
| 2 | Switch jack A * | 5 | MicroSD card slot |
| 3 | Switch jack B * |   |                   |

\* If you use a switch or switches for access to your device, plug them into switch jacks A and B. To use a joystick, you will need a Y-adaptor. If you have a joystick plugged in and it does not respond normally, reverse the way it is plugged in (plug switch A into jack B, switch B into jack A).

## Turning on the Device

1. Press and hold the power button located on the top edge of the device.
2. When you hear a beep, release the button. The green power LED will illuminate. The LED will remain illuminated while the device is on and while the device is in sleep mode.
3. Wait for the Empower® software to load.

## Using the Touchscreen

**Important!** Do not use sharp, pointed objects on the touchscreen. The touchscreen is designed to be used with your finger or the stylus that came with your device. This stylus is made specifically for a *capacitive* touchscreen. Anything else will harm your touchscreen and may cause your device to stop working.



The touchscreen is a liquid crystal display (LCD). Should the display break (unlikely except in extreme circumstances) and you come into contact with the liquid crystal, wash and rinse your skin thoroughly. Be careful to avoid splintered glass.

The touchscreen is very sensitive. Fingerprint smears, dust, grime, saliva, etc. will affect its performance. The screen also reacts to raindrops and extremes in temperature (condensation).

To dust the touchscreen, use a soft, lint-free cloth. For heavier cleaning, use a slightly dampened, lint-free cloth and then dry the screen with another soft, lint-free cloth.

## Charging the Battery

**Important!** Always use the battery charger that came with your device. Any other charger may damage the battery.



Locate the device in a safe location while charging.

How long the battery lasts depends on how you use your device. The time required to fully charge the battery varies depending on the charge level when the charge begins. When the device needs charging, locate the charging port on the back of the device and connect the battery charger.

The battery charge icon in the software's status area allows you to quickly view the battery charge level. The icon turns red when the battery charge is critically low; it turns green when the battery is charging.

### Charging a Dangerously Low or Dead Battery

To fully charge a dangerously low battery will take about 10 hours. If the battery is totally dead, an additional two hours may be required. A battery that is not fully depleted will require less time to recharge.

*Note:* If you need to use the device immediately, plug in the battery charger and leave it plugged in while using the device.

### Best Practice

Plug in your battery charger every night when you go to bed and any time you see the low battery warning and/or see the low battery LED come on. If you cannot plug in the charger overnight, it is best to power off the device to conserve battery charge.

## The Battery/Charging LED

**When the device is on and the charger is NOT plugged into the device:**

- The battery/charging LED is not illuminated.
- When the battery has less than 15% (about three hours) of its power remaining, the battery/charging LED will glow red.

**When the device is plugged into the charger:**

- *If the device is on:* The battery/charging LED will glow yellow. When the device is fully charged, the LED will turn green.
- *If the device is off:* The battery/charging LED will glow yellow. When the device is fully charged, the LED will turn off.

## Disposing of the Device and Batteries



**Device Disposal:** Please dispose of your device in accordance with your local, state, and/or federal electronic recycling laws.



**Battery Disposal:** If the batteries in your device need to be replaced, dispose of the old batteries in accordance with your local, state, and/or country regulations.

## Cleaning and Disinfecting the Device

If your device will only be used by one person, routine cleaning and disinfecting should be sufficient. If, however, more than one person will be using the device, take additional measures to clean and disinfect the device after it has been used by one person before allowing it to be used by another.



Disconnect the charger and turn off the device before cleaning or disinfecting the device.

## Routine Cleaning and Disinfecting

**Important!** Do not use solvents or abrasives or spray water or cleaner on the screen or case.

### Cleaning the Case

Before cleaning the case or the display, turn the device off. Clean the case with a slightly dampened, lint-free cloth. Dry the case thoroughly with another lint-free cloth before turning the device on.

### Cleaning the Touchscreen

The touchscreen is very sensitive. Fingerprint smears, dust, grime, saliva, etc. will affect its performance. The screen also reacts to raindrops and extremes in temperature (condensation).

To dust the touchscreen, use a soft, lint-free cloth. For heavier cleaning, use a slightly dampened, lint-free cloth and then dry the screen with another soft, lint-free cloth.

### Cleaning Keypad Frames, Keypads, and TouchGuides

All of these accessories can be removed from the case and washed in hot, soapy water. Dry them **thoroughly** before putting them back on the device. The best practice for regular cleaning is to dry accessories by hand, lay them on a dry towel, and let them air dry for about 5 minutes before placing them back on the device.

## Disinfecting

To disinfect everything but the display, use a solution of vinegar and water ( $\frac{1}{4}$  cup vinegar to 1 cup water). Wipe the case (not the display) using a cloth dampened with this solution.

Wash the keyguard frame, keyguard, and TouchGuide separately with the vinegar and water solution. Allow all equipment to air dry. **Do not use vinegar and water on the display!**

## What about drooling/saliva?

Any saliva should be wiped up immediately, especially on the touchscreen or around any of the connectors. Use a slightly dampened, lint-free cloth to wipe the device.

## What about spills, rain, or accidental immersion?

If you spill liquid or any runny substance on your device; if you're caught in a downpour; or if the device is accidentally dropped in liquid, immediately dry the device as thoroughly as possible. Try using the device. If it does not work, call the PRC Service Department and tell them what happened. They may ask you to send in your device for servicing.

## Disinfecting a Device and Accessories for Multiple Users

*Note:* This section applies only when more than one person will be using the same device. In that situation, it's vital to effectively disinfect the device and accessories that have been used by one person before allowing it to be used by another.

### First Step: Put on protective gloves

### Next Step: Clean the device and accessories

1. Wipe down the device and accessories with disinfectant wipes (Virucidal, Bactericidal, Pseudomonacidal, Tuberculocidal, Fungicidal)—Metrex CaviWipes™. Follow the disinfectant product manufacturer's instructions for *cleaning*.
2. Take a Q-tip with cleaner applied (for example, Windex® or another commercial cleaner) and clean inside all cracks and crevices. You may want to use a toothbrush or similar brush.
3. Blow the device off with an air hose or wipe it dry.

***Important! Make sure all soil is removed from the device and accessories. This is vital before proceeding to disinfecting the equipment.***

### Next Step: Disinfect the device and accessories

1. Wipe down the device and accessories with a new disinfectant wipe (Virucidal, Bactericidal, Pseudomonacidal, Tuberculocidal, Fungicidal)—Metrex CaviWipes. Follow the disinfectant product manufacturer's instructions for *disinfecting*.
2. Make sure to clean inside all cracks and corners, and wipe more than once if necessary to keep the device wet for a minimum of three (3) minutes.
3. Allow the device and accessories to dry.

### Final Step: Wipe the touchscreen

1. When the device and accessories are dry, wipe down the viewing area (device touchscreen, TouchGuide, keyguard, etc.) with glass cleaner, so the screen doesn't discolor.
2. Allow the equipment to dry.

## Positioning or Removing the Stand

 Do not carry the device by the stand. When carrying the device, use the handle or carry strap.

### Positioning the Stand

The stand provides multiple viewing positions. When latched against the back of the device, the stand provides a slight angle for viewing the screen when the device is sitting on a flat surface.

When you need an additional angle, extend the legs of the stand away from the back of the device by doing the following:

1. Place the device face-down on a flat surface.
2. Rotate the stand away from the back of the device.
3. Allow the stand to latch in the position you want.



Stand closed



Stand partially open



Stand fully open

## Removing the Stand

If you do not want to use the stand, you can remove it from the back of the device. You can reattach it at any time.

 Loose holders, screws, and washers could be a choking hazard.

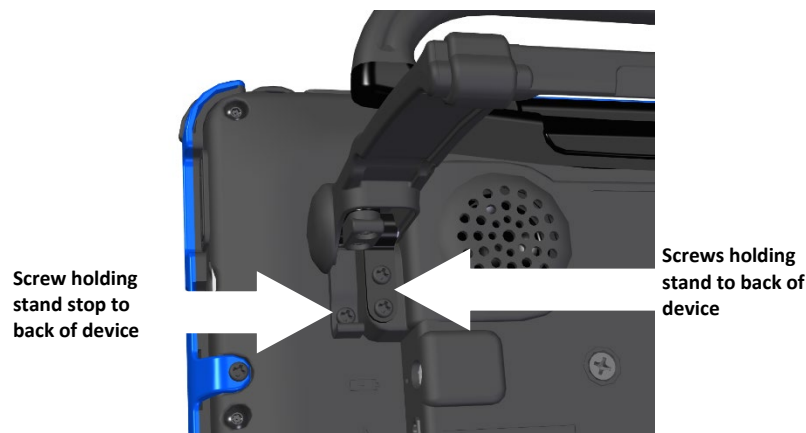

**First, place the device face-down on a flat surface.**

### To remove the stand:

- Using a Phillips screwdriver, remove the two screws from **each** side that hold the stand to the back of the device.
- Pull the stand free and put it in a safe place in case you need to use it later

### To replace a stand stop (in case it is broken, for example):

- Remove the two screws from the stand arm.
- Push the end of the stand arm out of the way. (Or remove the stand completely if you prefer.)
- Remove the screw holding the stand stop to the back of the device.
- Remove the old stop, replace it with the new stop, insert the screw, and reattach the stand.

## Removing or Reattaching the Handle

### To remove the handle from the device:

1. Using a Phillips screwdriver, remove the four screws that hold the handle in place.

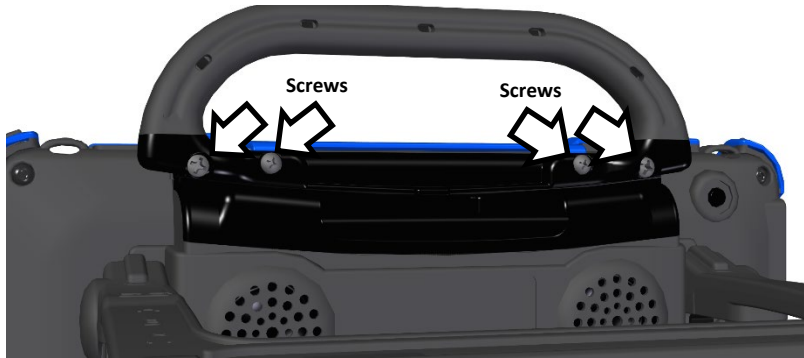

2. Pull the handle away from the device.
3. If you are not going to mount a NuPoint module, it is important to attach the port cover to protect the mini USB connector. See “Attaching the Top Port Cover” on page 16.

### To reattach the handle:

Remove the port cover or NuPoint module, line up the holes in the handle with the holes on the back of the device, and insert the two screws.

## Attaching the Top Port Cover

If you removed the handle and are not going to mount a NuPoint module, it is important to attach the port cover to protect the Mini USB Connector on the top of the device.

1. Line up the holes in the cover with the holes on the back of the device.



2. Insert and tighten the two screws that previously secured the handle.



### To remove the port cover:

Remove the two screws that hold the port cover in place. Use the screws to mount a NuPoint module or to reattach the handle.

*Note:* Store the port cover where you can find it if you need to use it again.



## Mounting the IR Reflector on a Non-Dedicated Device

*Note:* Infrared (IR) functionality is only available on non-dedicated devices.

Your device emits infrared signals from the IR area on the back of the device. The optional IR reflector allows the user to better “aim” those signals from any position. If you have the IR reflector, follow these instructions to attach it to the device.

The IR reflector can be mounted on the device handle, port cover, or NuPoint module, depending on which is already attached to your device. The reflector kit includes the reflector, two short screws, and two long screws.

1. Using a Phillips screwdriver, remove the appropriate screws, as shown.

**Handle:** If the handle or port cover is attached to your device and the frame is attached with screws, remove the top frame screws.

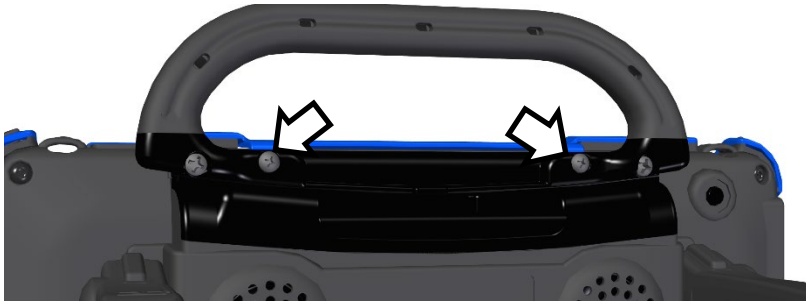

**NuPoint Module:** If a NuPoint module is attached to your device, remove the two inside screws from the module.

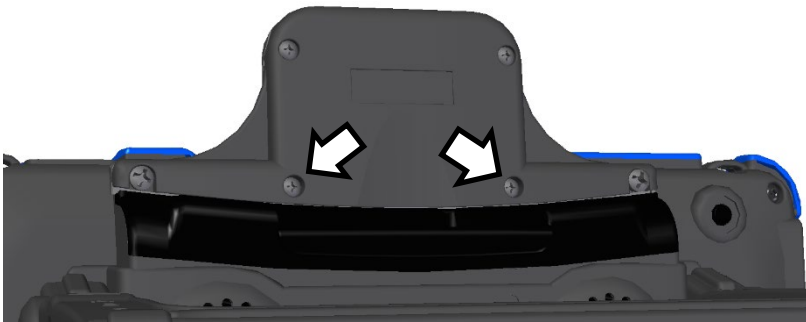

2. Align the holes in the reflector with the empty holes in the frame, port cover, or NuPoint module.  
**Important!** Make sure the reflective shield is aimed downward toward the back of the device, as shown in step 3.
3. Insert the appropriate screws in the holes, as shown.

### Handle or Port Cover

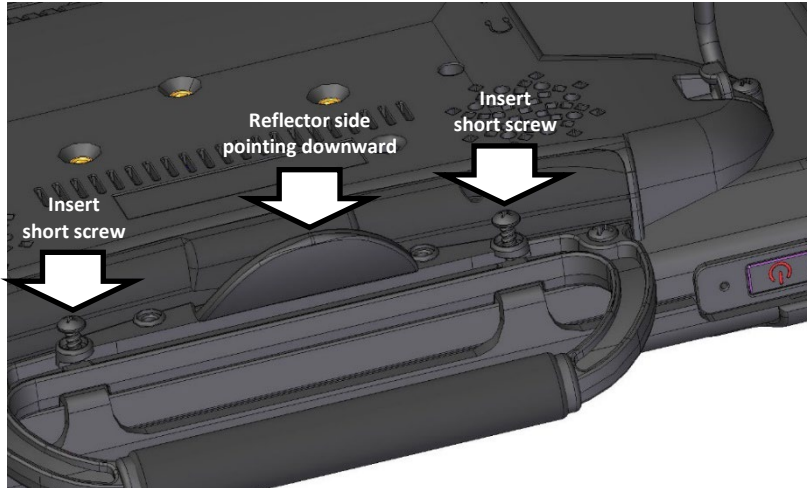

### NuPoint Module

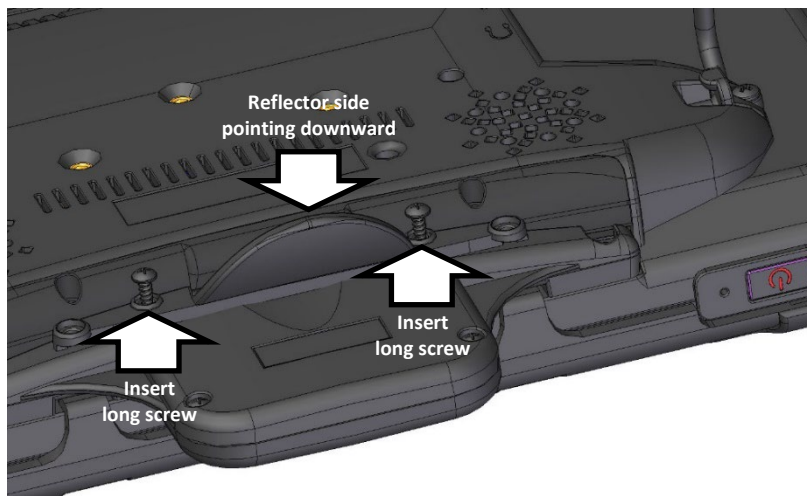

4. Tighten the screws.

## Applying a Screen Protector

If you plan to use a screen protector, you must first remove the device frame. To remove the frame, see “Removing or Replacing the Device Frame” on page 20.

There are six screen protectors in the kit. Three have a matte finish and three have a luster finish. The matte finish offers the most glare resistance. Matte protectors can be identified by the small red square on the backing.

1. Turn your device off and lay it flat on a table.
2. Remove dust and fingerprints from the screen using a lint-free cloth dampened with water or flat-screen TV cleaner.

**Hint:** Do not dry the screen before applying the screen protector. You may find it easier to smooth out the protector and remove air bubbles (step 7 below) if the screen is slightly damp.

3. Peel a screen protector from its backing.
4. Hold the protector along the edges, with the side that was against the backing now facing the screen.
5. Align one edge of the protector with one edge of the screen.
6. Press the protector onto the screen, adjusting the protector until it covers the screen along all edges.
7. Use the squeegee included to smooth out the protector and remove air bubbles and wrinkles.



8. Wipe the protector with a lint-free cloth to remove any fingerprints.

**Hint:** Regularly wipe off the protector with a damp lint-free cloth to remove fingerprints, smudges, etc. If the protector becomes too dirty, peel it off and replace it with a new protector.

## Removing or Replacing the Device Frame

Your device came with a frame mounted on it. If you need to remove or replace the frame, follow these instructions.

### Removing the Frame

1. If you are using a keyguard or TouchGuide, remove it from the frame. See “Removing the Keyguard” on page 23 or “Removing the TouchGuide” on page 25.
2. Using a Phillips screwdriver, remove the four screws that secure the frame to the device—two on the top and one on each side.

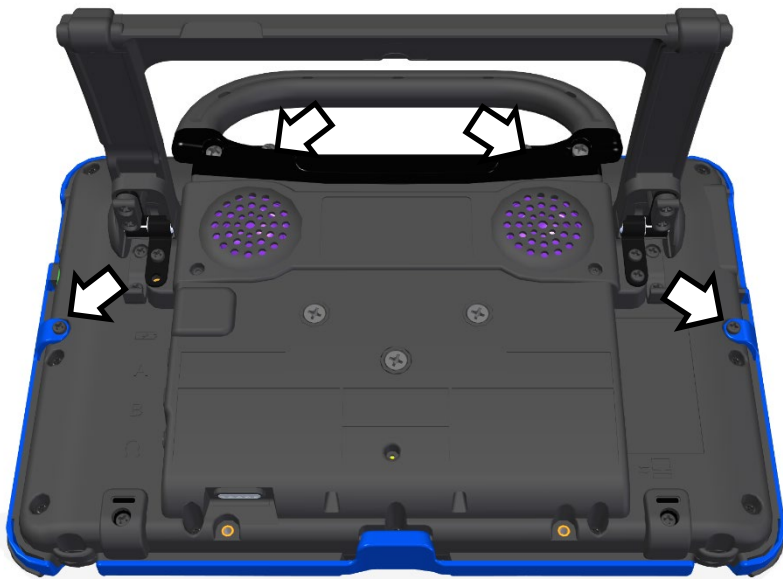

**Important!** If you are replacing the frame, set the screws aside. You will use them to reattach the new frame. If you are not replacing the frame, store the screws in a safe location in case you later decide to reattach the frame.

 Loose screws could be a choking hazard.

3. Grasp one side of the frame and pull it loose from the device.  
*Hint:* You may want to use a flat-head screwdriver or similar tool to gently lift the side and bottom tabs on the back of the device.
4. Grasp the other side of the frame and pull it loose from the device.  
*Note:* When you pull the other side loose, the top or bottom tabs (steps 5 and 6) may pull out at the same time
5. Pull the tabs on the top of the frame out of the slots on the device.
6. Pull the tab on the bottom of the frame out of the slot on the device.
7. Proceed to the next section, “Attaching the New Frame”.

## Attaching the New Frame

You must attach the device frame before you can mount a keyguard or TouchGuide over the screen.

1. Press one side of the frame onto the edge of the device.
2. Pull the other side into place.  
*Note:* The top tabs may snap into place as you pull on the side.
3. If necessary, press the top tabs into place.
4. If necessary, pull the bottom tab into place.
5. Look along the inside edge of the frame along the top, bottom, and sides to make sure the rubber backing didn't bunch up between the frame and the edge of the device.

If necessary, lift up the inside edge slightly and press until the rubber backing fits smoothly between the frame and device.

6. To secure the frame to the device with screws, proceed to the next section, "Attaching the Frame More Securely".

## Attaching the Frame More Securely

If you do not expect to remove and reattach the frame to the device frequently, you may want to insert the original screws in the top and side holes of the frame. If you expect to remove and reattach the frame to the device frequently, you may not want to use the screws.

1. Place the device face-down on a flat surface.
2. Insert the two screws with wood-style threads that you removed earlier (page 20, "Removing the Frame", step 2) through the holes in the top of the frame and into the corresponding holes in the top of the device.
3. Insert the other two screws that you removed earlier through the holes in each side of the frame and into the corresponding holes in the sides of the device.
4. Tighten all four screws with a Phillips screwdriver.

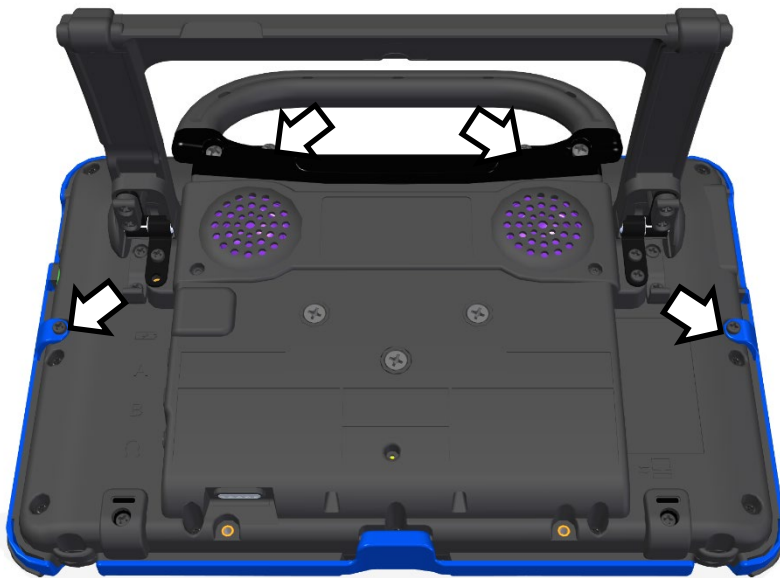

### When the device frame is attached securely:

After you attach the frame securely to the device, you can attach a keyguard or TouchGuide to the frame. See "Attaching the Keyguard" on page 22 or "Attaching the TouchGuide" on page 24.

## Attaching, Raising, and Removing a Keyguard

Your device came with a frame mounted on it. The keyguard attaches to the frame. If you removed the frame, first reattach it, referring to “Removing or Replacing the Device Frame” on page 20.

### Attaching the Keyguard

1. Hold the keyguard over the screen, with the pins toward the top of the screen and the tabs toward the bottom.

**Important!** Position the keyguard so that the tabs are on the bottom. The tabs must be able to lie flat against the screen, allowing the keyguard to snap into place.

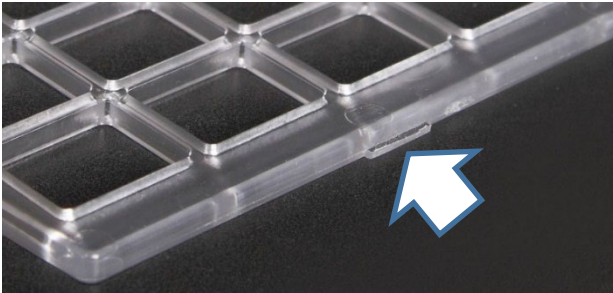

2. Insert one of the keyguard pins into the opening near the top of the device frame.



3. While holding the pin in place, lift upward with your fingers to bend the middle of the keyguard upward slightly. Then insert the other pin into the opening on the other side of the device frame.



4. Press down on the bottom portion of the keyguard to snap the tabs into place.

**Note:** If the keyguard tabs at the bottom do not snap into place, make sure that the Keyguard is not upside-down. (See step 1.)

## Raising the Keyguard

If you need temporary access to the screen—for example, for programming, changing device settings, cleaning the screen, etc.—you can raise the keyguard without removing it completely. If you want to remove the keyguard from the device completely, see “Removing the Keyguard” below.

1. While holding the bottom edge of the device with one hand, use the thumb of your other hand to grasp the bottom edge of the keyguard in the middle.
2. Pull upward to release the bottom tabs.
3. Leaving the pins inserted in the top of the device frame, the bottom of the keyguard will remain in the upright position, giving you

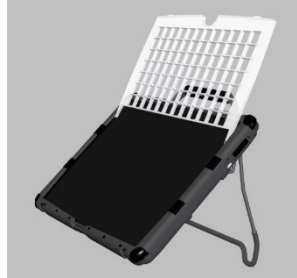

device frame, simply lift the screen. The keyguard will easily access to the screen.

## Removing the Keyguard

1. While holding the bottom edge of the device with one hand, use the thumb of your other hand to grasp the bottom edge of the keyguard in the middle.
2. Pull upward to release the bottom tabs.
3. Lift upward with your fingers to bend the top-middle portion of the keyguard upward slightly.

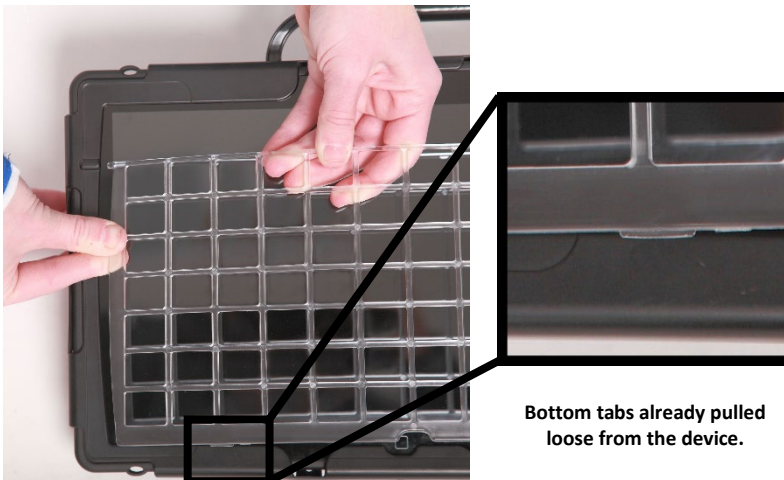

Bottom tabs already pulled loose from the device.

4. Pull the pins out of the openings at the top of the device frame.

# Attaching or Removing a TouchGuide

Your device came with a frame mounted on it. The TouchGuide attaches to the frame. If you removed the frame, first reattach it, referring to “Removing or Replacing the Device Frame” on page 20.

## Attaching the TouchGuide

1. Align the TouchGuide so that the two squares at the top are positioned at the upper right corner of the display.

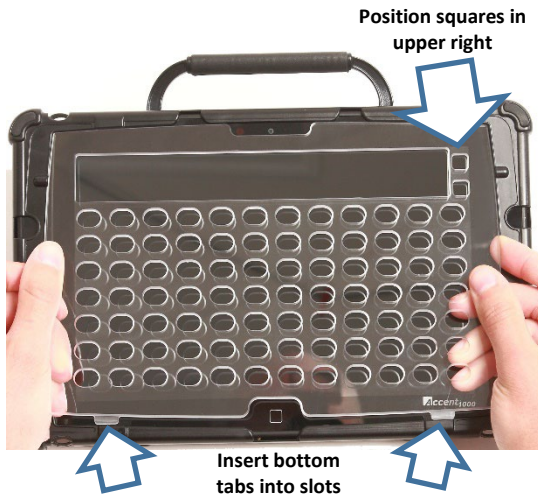

Then insert the bottom tabs of the TouchGuide into the slots at the bottom edge of the frame.

2. With the bottom tabs in place, lift upward with your fingers to bend the top right corner of the TouchGuide slightly and insert the tab into the top right slot of the frame.



**Note:** The TouchGuide plastic is stiff and may require some effort to bend.

3. Insert the left tab into the top left slot of the frame using the same method as in step 2.
4. To make sure the TouchGuide fits flat against the screen, push down on the TouchGuide in each of the four corners to seat it into the rubber completely.

*Hint:* Pulling up on the corners of the frame slightly while pushing down on the TouchGuide corners also helps to nestle the TouchGuide into the rubber.



## Removing the TouchGuide

1. Grasp the plastic above the first row of keyholes.



2. Pull out and down on the TouchGuide until the upper tabs pop out.

## Attaching a Carry Strap

PRC offers two sizes of straps for your device. The shorter strap adjusts from 28 inches to 36 inches and is included with some orders. A longer strap adjusts from 38 inches to 60 inches. For details and pricing, please call PRC inside sales at 800.262.1933 or visit <https://store.prentrom.com> and select Accessories and then Carry Case & Strap.

At each end of the strap there is a loop connector with a quick-release connector on the strap side. The device strap holders are located on the top and bottom of the device.

1. Decide whether to connect the carry strap to the top or bottom holders on the device.



2. Detach the loop connector from the strap by pressing in on the sides of the quick-release connector.



3. Thread the loop through a strap holder on the device. A small straight object like a needle may be helpful to pull the loop through the holder.



4. Thread the loop connector through the loop.



5. Pull the connector through until it is tied securely to the device.



6. Insert the loop connector into the strap connector until they click and hold together.



7. Repeat these steps to connect the other end of the strap to the device.

## Attaching a Strap Handle

The strap handle allows you to carry your Accent device with one hand comfortably. Connectors on the ends of the handle attach to the holders on the top (or bottom) of the device.

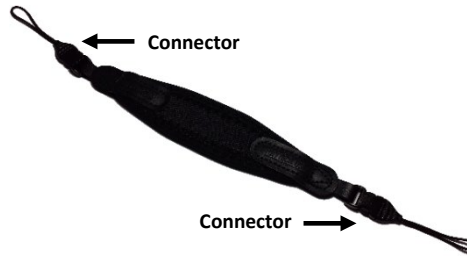

1. If the standard handle is attached to your device, remove it by removing the screws. See “Removing or Reattaching the Handle” on page 15.
2. Attach the port cover included with your device to protect the Mini USB connector on the top of the device. See “Attaching the Top Port Cover” on page 16.
3. Attach the strap handle the same way you would attach a carry strap. Follow steps 2 through 7 under “Attaching a Carry Strap” on page 26.

The strap handle can also be attached diagonally across the back of the device for one-handed carrying and/or operation. Attach the strap handle from the top left strap holder to the bottom right strap holder or from the top right strap holder to the bottom left strap holder.

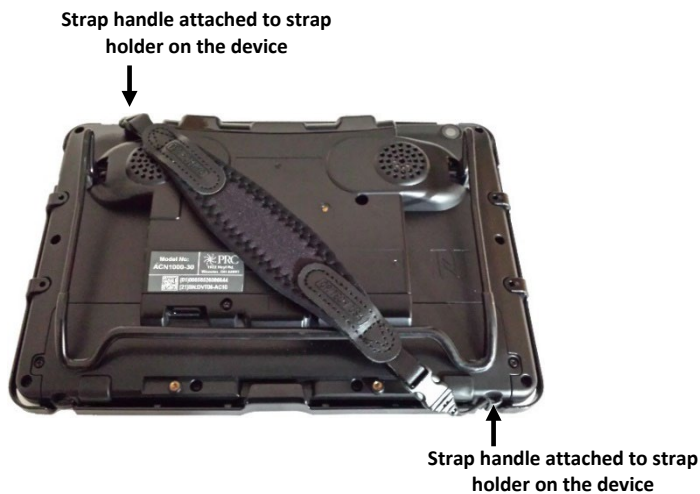

For one-handed carrying and/or operation, slide your hand between the strap handle and the back of the device.



 If you use the strap handle across the back of the device, use extreme caution and make sure you have a firm grip on the device.

## Attaching a QRM Mounting Plate

Your device can be mounted on a table stand or a wheelchair mount. If you purchased the QRM mounting plate with your device, the plate is already mounted on the back of your device. If you purchased the QRM mounting plate separately, or if you need to replace it, follow these instructions.

**Important!** The mounting plate's screws are held in place on the plate with retaining washers. *Do not remove the washers.*

### To attach the QRM mounting plate to the device:

1. Place the device face-down on a flat surface. Be careful not to scratch the display.
2. Using a Phillips screwdriver, remove the three screws that are already in the mounting holes.

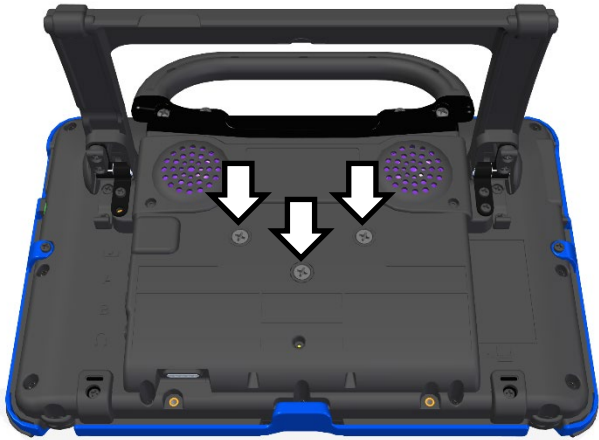

3. Align the screws in the mounting plate with the threaded holes on the back of the device.
4. Tighten the screws.

### To remove the QRM mounting plate:

1. Loosen the screws just enough that you can pull the plate off the back of the device.
2. Leave the screws held in place by the washers.
3. Store the plate (with the screws held in place) in a safe location in case you need to mount it later.

## Mounting a NuPoint Module

**Important!** The NuPoint module must be securely attached to the device with all screws to operate properly.

If you purchased a NuPoint module with your device, the module is already mounted on the device. If you purchased the module later, follow these instructions to attach it to the device. You can attach the module to a device with or without a frame.

**Note:** Your device may look slightly different from the device shown in these photos.

1. Using a Phillips screwdriver, remove the device handle or port cover. See “Removing or Reattaching the Handle” on page 15 or “Attaching the Top Port Cover” on page 16. You will use the screws you remove from the handle or port cover to fasten the NuPoint module to the device.

**Important!** If the device has a frame attached, remove the two top screws that hold the frame in place. Otherwise, the NuPoint module will not mount properly. Store these screws in a safe location or discard them.

 Loose screws can be a choking hazard.

2. Align the connector and screw holes on the NuPoint module with the NuPoint USB connector and screw holes on the top edge of the back of the device.
3. Slide the module into place, making the sure the connectors are engaged completely.
4. Tighten the two screws you removed in step 1 to secure the module to the device.

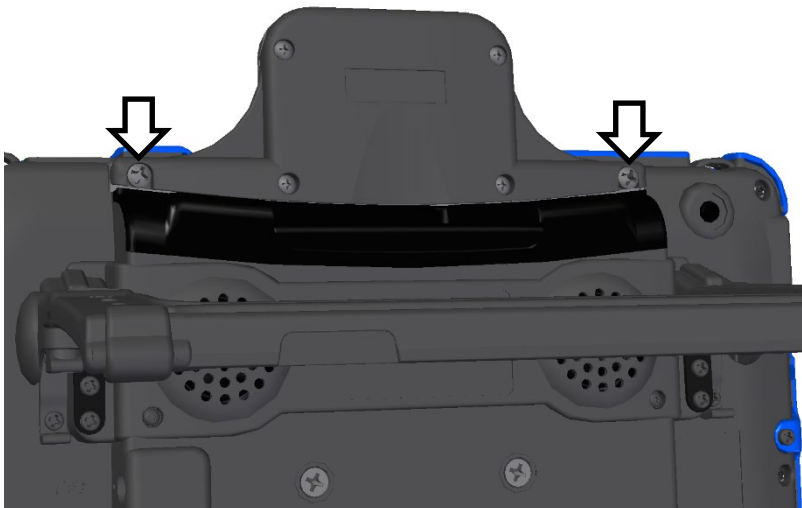

5. The NuPoint module is ready to set up for use. For detailed instructions on customizing settings, refer to the *NuPoint User's Guide*.

## Using a Strap Handle with a NuPoint Module

You can use a strap handle to carry your device when a NuPoint module is mounted on the device. Attach the strap handle to the strap holders either across the top or diagonally across the back. See “Attaching a Strap Handle” on page 24.



# Getting Started with the NuVoice Software

## Putting the Device to Sleep/Waking the Device

When you finish using the device for the day, put it in sleep mode overnight. This allows Windows® updates to download. To put the device to sleep, do either of the following:

- Quickly press and release the power button *or*
- Select the **Sleep** key in the NuVoice Toolbox

When the device is inactive for a prolonged period, it will go into sleep mode automatically. The green power LED will remain illuminated while the device is in sleep mode. To wake the device, do either of the following:

- Select the Tools key on the front of the device *or*
- Quickly press and release the power button

*Note:* The device may wake up if an eye tracking module is attached or if Windows updates are set to install automatically. To preserve the charge overnight, either connect the charger or power off the device. Transporting the device in a carry case may also wake it. In that case, power off the device.

## Restarting the Device

*Recommendation:* Restart your device once per week if you don't normally turn it off at night or every few days. When the device won't be used for more than a couple days or when it will be transported in a carry case, power it off instead (see "Powering Off the Device" below). To restart the device:

1. Select the **Tools** key and then select the **Toolbox** key.
2. Select **Maint Menu** and then select **Power Management**.
3. Select **Restart** and then select **Yes** at the confirmation prompt.

## Powering Off the Device

*Recommendation:* Power off the device when it won't be used for more than a couple days or when it will be transported in a carry case.

1. Select the **Tools** key.
2. Select the **Shutdown** option.
3. Select **Yes** at the confirmation prompt.

## Selecting a Vocabulary

Your PRC device shipped with one of four configurations: the Unity® language system, the UNIDAD® bilingual system, the Essence® language system, or the WordPower® language system. Below are brief descriptions of each configuration as well as places to go for additional information.

For more information, contact your regional consultant by performing a zip code search on our website [www.prentrom.com](http://www.prentrom.com). Click **PRC Advantage**, scroll down, and select **PRC Consultants**. Enter your zip code under the “Find your consultant” box on the right.

### The Unity Device Configuration

The Unity configuration gives individuals access to the Unity family of vocabularies: the Unity vocabularies, the LAMP Words for Life® vocabularies, and the CoreScanner™ vocabularies.

#### Unity language system

The Unity language system is a way to organize language that is unique to PRC. It uses easy-to-understand pictures to represent words and word endings. It starts out at simple cause and effect and grows to adult language. It comes in 4, 8, 15, 28, 36, 45, 60, 84, and 144 locations and has a *1-hit* and *sequenced* version. It can be used with beginning communicators as well as advanced communicators.

For more information, take a variety of free online courses. You will find these courses by going to our website [www.prentrom.com](http://www.prentrom.com) and clicking **Education**.

A Unity-configured device ships with Unity vocabularies as the default.

#### LAMP Words for Life language system

The LAMP Words for Life (WFL) language system is also a way to organize language which is unique to PRC. Its foundations are in the Unity language system, so you are going to see similarities between the two programs. The LAMP WFL language system was authored for people with autism, but it can be used by individuals with other disabilities. It is typically used in conjunction with the LAMP approach. It comes in 84 locations and has a *1-hit*, *transition*, and *full* version. It can be used with beginning communicators as well as advanced communicators.

For more information, take a variety of free online courses. You will find these courses by going to our website [www.prentrom.com](http://www.prentrom.com) and clicking **Education**.

To learn more about the LAMP approach, visit The Center for AAC and Autism [www.aacandautism.com](http://www.aacandautism.com)

To load the LAMP WFL language system, do the following:

1. Select the **Tools** key, select the **Toolbox** key, and then select **User Area Menu**.
2. Select **Replace User Area** and then select the vocabulary you want to replace.
3. Select **Pre-defined Vocabularies, English, and LAMP Words for Life**. Then select the specific vocabulary you want.
4. Select **Yes** to confirm the replacement.
5. On the keyboard page, type **replace** and select **OK**.
6. When the question “Switch to this User Area now?” appears, answer **Yes** or **No**.
7. Select **OK** twice to return to the vocabulary screen.
8. If you want to load all three LAMP WFL vocabularies, follow these same steps, selecting a different user area for each.



## CoreScanner language system

The CoreScanner language system is a progressive vocabulary program specifically designed for individuals with physical disabilities, who best access a communication device through the use of a switch. The CoreScanner design is based on the foundations of the Unity language system and the LAMP approach that have proven effective for so many people, and on the following principles: motor planning, single words, robust core vocabulary, and frequency of use. It is never too late for anyone to begin to use CoreScanner vocabularies. However, it is also true that language development begins in infancy and progresses in a relatively predictable way. It is therefore never too early to begin to learn to communicate. The CoreScanner language system seeks to provide access to a progressive and fundamentally sound language application for the earliest language learners.

For more information, take a variety of free online courses. You will find these courses by going to our website [www.prentrom.com](http://www.prentrom.com) and clicking **Education**.

To configure the entire device to the CoreScanner program, do the following:

1. Select the **Tools** key, select the **Toolbox** key, and then select **Maint Menu**.
2. Select **Change Product Configuration**.
3. Select **CoreScanner**. All six user areas will be replaced with CoreScanner.
4. Select **Yes** to confirm the replacement.
5. Select **OK** twice to return to the vocabulary screen.

## The UNIDAD Bilingual Device Configuration

The UNIDAD bilingual configuration ships with Spanish/English versions of Unity (the UNIDAD language system) and the LAMP Words for Life language system (LAMP Words for Life Spanish/English vocabularies). It is intended for monolingual Spanish speakers or bilingual Spanish/English speakers. The UNIDAD language system contains six vocabularies, three in English and three in Spanish. It comes in 36, 60 (coming soon), and 84 locations. The LAMP Words for Life Spanish/English vocabularies are available in two versions: 84 1-hit and 84 Full. An individual can easily navigate from English to Spanish with the click of a key in either the UNIDAD vocabularies or LAMP Words for Life Spanish/English vocabularies.

A UNIDAD-configured device ships with UNIDAD software and LAMP Words for Life Spanish/English vocabularies as the default. When purchased as an add-on to a Unity-configured device, UNIDAD vocabularies and settings can be loaded as a product configuration. To configure the device for UNIDAD vocabularies, follow steps 1-5 under “CoreScanner” above, substituting **UNIDAD** for **CoreScanner** in step 3.

## The Essence Device Configuration

The Essence configuration is a popular alphabet-based program designed for literate users, including adults with ALS. It uses a combination of spelling, word completion, next word prediction, abbreviation expansion, and quick messages to express novel thoughts and routine communication. Literate individuals quickly learn to communicate with this alphabet-based program.

For more information, visit [www.prentrom.com/essence](http://www.prentrom.com/essence).

An Essence-configured device ships with Essence vocabularies as the default. When purchased as an add-on to a Unity-configured device, Essence vocabularies and settings can be loaded as a product configuration. To configure the device for the Essence language system, follows steps 1-5 under “CoreScanner” above, substituting **Essence** for **CoreScanner** in step 3.

## The WordPower Device Configuration



The WordPower language system is uniquely designed by Inman Innovations. The WordPower configuration has two versions, WordPower and Picture WordPower. The WordPower vocabularies are word-based and give individuals access to a keyboard, word prediction, and core vocabulary. The Picture WordPower vocabularies are similar but provide more picture support. They come in 45, 60, 84, and 144 locations. Versions are available with and without a keyboard on the home screen. For more information, visit <http://www.inmaninnovations.com/>.

A WordPower-configured device ships with WordPower vocabularies as the default. When purchased as an add-on to a Unity-configured device, WordPower vocabularies and settings can be loaded as a product configuration. To configure the device for the WordPower language system, follow steps 1-5 under “CoreScanner” above, substituting **WordPower** for **CoreScanner** in step 3.

## Using the Exploration Wizard

1. Use the Wizard to select one of the vocabulary options or the Target Practice exercise or Picture Test exercise.
2. If the vocabulary you want does not appear on the Wizard, follow the steps under “Changing the Vocabulary” or “Replacing the Vocabulary” below.
3. To return to the Wizard from a vocabulary screen, follow the steps under “Changing the Vocabulary” below.

## Accessing the Toolbox

The Toolbox is the area where you can make changes to the device. Access the Toolbox by selecting the **Tools** key  and then select the **Toolbox** key  from the pop-up menu. As an alternative, you can select the **Tools** key twice.

## Changing the Vocabulary

Follow these steps to switch from one available vocabulary to another.

1. Select the **Tools** key and then select the **Toolbox** key.
2. Select **User Area Menu**.
3. Select **Switch User Area**. Then select the vocabulary you want and wait for it to load.
4. Select **OK** twice to return to the vocabulary screen.

*Note:* If the vocabulary you want is not available in the Switch User Area, see the next section, “Replacing the Vocabulary”.

## Replacing the Vocabulary

Follow these steps only if you want to completely replace one vocabulary on your device with another.

1. Select the **Tools** key, select the **Toolbox** key, and then select **User Area Menu**.
2. Select **Replace User Area** and then select the vocabulary you want to replace.
3. Select the vocabulary folder. Then select the specific vocabulary you want.
4. Select **Yes** in the yellow message box to continue.
5. On the keyboard page, type **replace** and select **OK**.
6. In the User Area Menu, select **Switch User Area**. Then select the new vocabulary.
7. Select **OK** twice to return to the vocabulary screen.

## Changing the Voice

1. Select the **Tools** key and then select the **Toolbox** key.
2. Select **Speech Menu**.
3. Select **Change Voice** and then the voice you want.
4. Use the **Test Speech** button to hear the selected settings.
5. Select **OK** twice to return to the vocabulary screen.

## Turning Speech On or Off

1. Select the **Tools** key and then select the **Toolbox** key.
2. Press the **Speech On/Off** key in the Toolbox. When speech is turned on, the Speech indicator in the status area will turn green (Classic skin option) or the Speech bubble will be displayed (Skin 1 or Skin 2).

## Adjusting the Volume



To prevent possible hearing damage, do not listen to earphones at high volume levels for long periods.

1. Select the **Tools** key and then select the **Toolbox** key.
2. Select the **Speaker Volume Up** key or **Speaker Volume Down** key.
3. Select **OK** to return to the vocabulary screen.

## Correcting the Pronunciation of a Word

To “teach” your device to pronounce a word correctly:

1. Select the **Tools** key and then select the **Toolbox** key.
2. Select **Pronunciation Dictionary**.
3. Choose either **Main Voice** or **Prompt Voice**. The Manage Pronunciations screen will be displayed.
4. Select **Add Pronunciation**.
5. Enter the correct spelling of the word and select **OK**.
6. Enter the phonetic spelling of the word.
7. To test the pronunciation immediately, select the message window. If the pronunciation is not correct, change it and test again. When the pronunciation is correct, select **OK**. The word will be listed on the Manage Pronunciations screen.

*Note:* You can test the pronunciation of any word listed on the Manage Pronunciations screen by selecting **Test Pronunciation**.

8. Select **OK** to exit the Manage Pronunciations screen.

## Changing the Access Method

To change the method you use to control your device:

1. Select the **Tools** key and then select the **Toolbox** key.
2. Select **Access Method Menu** and then select **Choose Different Access Method**.
3. Select **Touch**, **1 Switch**, **2 Switch**, **Headpointing/Joystick**, or **Eyegaze**. The Access Method Menu will show the method you selected.
4. From the Access Method Menu, change the access method settings as necessary.

## Accessing the Setup Key

1. Select the **Tools** key.
2. From the slide-out menu, select **Setup Key**.
3. Select the key you want to customize.

## Customizing a Key

1. Be looking at the key you want to customize. Select the **Tools** key and then select **Setup Key**.
2. Select the key and select **Change Icon**. Do one of the following:
  - *Use an image available on the device:* Select **Spell Icon to Find**, spell what you are looking for, and select **OK**. Touch the icon you want or select an icon category and browse to the icon you want.
  - *Take a picture:* Select **Take Picture**. Frame the picture and then select **Take Picture**. Select **Save as Icon, Rename Icon**, and **OK**. See also “Taking Your Own Photo to Use on a Key” below.
  - *Use your own photo:* Plug a USB flash drive that has the photo you want into the device. Select **Import Icon**. If the content of the flash drive is showing, touch the photo you want to import. If not, select **Up Folder** to navigate to the flash drive, and then touch the photo. Select **OK**, select **OK** again, and then select **Cancel**. The photo will be placed on the key and in the imports folder of the icon dictionary.
  - *Search for an icon by category.*
3. Check to see if the “text to speak” is correct. If not, select **Spell Message or Define Key Function** to type text that will appear in the display. Be sure to put a *space* after the last character. Select **OK**.
4. Check to see if the key label is correct. If it isn’t, select **Change Label** and then select **OK**.
5. Select **OK** or **Choose Next Key to Define**.

## Taking Your Own Photo to Use on a Key

The front and rear cameras allow you to take pictures to use as icons and visual scenes. These icons and scenes help personalize an individual’s communication. For example, a picture of the individual’s mom could be used as an icon on a “Mom” key. (See “Customizing a Key” above.) This would help the individual specify his or her mom, as distinguished from moms in general.

1. Select the **Tools** key and then select the **Toolbox** key.
2. Select **Camera Menu**.
3. Frame the picture in the view finder. Select **Take Picture**.
4. Select **Save as Icon**.
5. Select **Rename Icon**, select **Clear Display**, type a name, and select **OK**.
6. Select **OK** again. The photo will automatically be placed in the Imports folder.  
*Note:* When changing an icon, your photos will be in the category called Imports.
7. Select **OK** and then select **Go to Home**.

## Disabling and Enabling the Toolbox

When you disable the Toolbox, you can still use your vocabulary to speak, but the Tools key will not take you from Core or your Home page to the Toolbox without entering a password.

### To Disable the Toolbox

1. Select the **Tools** key and then select the **Toolbox** key.
2. Select **Maint Menu**.
3. Select **Disable Toolbox**. Under “Toolbox”, select **Disable**. The first time you disable the Toolbox, you must enter a password. Type a password and select **OK**.

**Important!** Remember your password. You’ll need it when you want to re-enable the Toolbox. This password will remain in effect the next time you disable the Toolbox.

4. Select **OK** and select **OK** again.

### To Enable the Toolbox

1. Select the **Tools** key.
2. Enter your password and select **OK**.
3. Select the **Toolbox** key.
4. Select **Maint Menu**.
5. Select **Disable Toolbox**. Under “Toolbox”, select **Enable**.
6. Select **OK** and select **OK** again.

## Backing up Your Vocabularies

1. Insert your flash drive into the USB port on the back of the device.
2. Select the **Tools** key and then select the **Toolbox** key.
3. Select **Transfer Memory Menu**.
4. Select **Save One User Area** and touch the user area you want to back up or select **Save Entire Device Contents**.
5. Make sure the pre-set folder is a USB drive. If so, select **OK**. Type the file name and date (xx-xx-xx).
6. Select **OK** and wait for the information to be transferred. When the transfer is complete, select **OK**.

## Updating the NuVoice Software via a Wi-Fi® Connection

*Recommendation:* Install NuVoice updates as soon as they are available.

To perform this type of update, your device must be connected to a Wi-Fi network.

*Note:* If you have a dedicated device, a Wi-Fi connection will allow you to update your NuVoice software via the Internet, but will not provide access to the Internet or an Internet browser.

1. Select the **Tools** key and then select the **Toolbox** key.
2. Select **Maint Menu** and then select **Software Update Menu**.
3. Select **Internet Update** and follow the on-screen prompts.

## Updating the NuVoice Software via USB Flash Drive

*Recommendation:* Install NuVoice updates as soon as they are available.

1. Insert your USB flash drive into the computer to which you will download the software update.
2. Go to <https://www.prentrom.com/support/accent>.
3. Under “Featured Downloads” select **Download: USB Flashdrive Software Update**.
4. Under “Accent USB Flashdrive Software Update”, click **Download**.
5. At the “Do you want to open or save” prompt, click the arrow to the right of “Save”, select **Save As**, and save the file to your computer’s desktop.

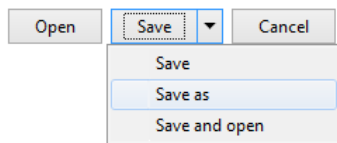

6. Turn on your device and plug in the battery charger.
7. Copy the downloaded file from your computer’s desktop to your USB flash drive.
8. Remove the USB flash drive from your computer and insert it into your device.
9. On the device, go to the Toolbox and select **Maint Menu**.
10. Select **Software Update Menu**, select **USB Update**, and follow the on-screen prompts.
11. When the update process is finished, remove the USB flash drive from your device.

*Note:* Once your device is running the updated software, you can unplug the battery charger.

## Finding Additional Information

More specific information on using access methods and vocabularies is available in the manuals and instructions included with your PRC communication device and accessories.

For detailed information on changing NuVoice settings, refer to the *NuVoice Software Manual*, available from <https://www.prentrom.com/support/accent>

For information on using an Accent 800 device with Empower software, view or download the *Accent 800 User’s Guide for Empower* from <https://www.prentrom.com/support/devices/accent-with-empower>.

# Appendix: Compliance Information

## Federal Communications Commission (FCC) Warning

This device complies with Part 15 of the FCC Rules. Operation is subject to two conditions: (1) this device may not cause harmful interference, and (2) this device must accept any interference received, including interference that may cause undesired operation.

Changes or modifications to this product which are not authorized by PRC-Salttillo could exceed FCC limits and negate your authority to use this product.

*Note:* This equipment has been tested and found to comply with the limits for a Class B digital device, pursuant to Part 15 of the FCC Rules. These limits are designed to provide reasonable protection against harmful interference in a residential installation. This equipment generates, uses and can radiate radio frequency energy and, if not installed and used in accordance with the instructions, may cause harmful interference to radio communications. However, there is no guarantee that interference will not occur in a particular installation. If this equipment does cause harmful interference to radio or television reception, which can be determined by turning the equipment off and on, the user is encouraged to try to correct the interference by one or more of the following measures:

- Reorient or relocate the receiving antenna.
- Increase the separation between the equipment and receiver.
- Connect the equipment into an outlet on a circuit different from that to which the receiver is connected.
- Consult the dealer or an experienced radio/TV technician for help.

## Industry Canada (IC) Warning

This device complies with Industry Canada license-exempt RSS standard(s). Operation is subject to the following two conditions: (1) This device may not cause interference, and (2) This device must accept any interference, including interference that may cause undesired operation of the device.

Le présent appareil est conforme aux CNR d'Industrie Canada applicables aux appareils radio exempts de licence. L'exploitation est autorisée aux deux conditions suivantes: (1) l'appareil ne doit pas produire de brouillage, et (2) l'utilisateur de l'appareil doit accepter tout brouillage radioélectrique subi, même si le brouillage est susceptible d'en compromettre le fonctionnement.

## Wireless Communications Equipment

Wireless communications equipment such as wireless home network devices, mobile phones, cordless telephones and their base stations, and walkie-talkies can affect this device and should be kept a least six (6) inches away from the device.

## Limitation of Intended Use, Third Parties, and Data Loss

- PRC-Salttillo does not warrant any functionality of this speech generating device outside the terms of its express warranty relating to the intended use of speech generation. PRC-Salttillo does not warrant any third-party software, nor is it responsible for any injury, damage or claims arising from the function or malfunction of any third-party technology, websites, products, and software. Additional uses may require further clinical determinations beyond the scope of an evaluation for speech generation devices.
- PRC-Salttillo assumes no responsibility for any loss or claims by third parties which may arise through the use of this product.
- PRC-Salttillo assumes no responsibility for any damage or loss caused by the deletion of data as a result of malfunction repairs or battery replacement. Be sure to back up all important data on other media (computer) to protect against its loss.

## Device Intended Purpose

The Accent 800 is a speech generating device that augments communication for an individual with speech/language impairment. This device and its language programs give the user the ability to initiate conversation, seek information, state opinions, and share feelings. It can be hand-held, used with a table stand, or mounted to a wheelchair. It is accessed by using the touchscreen, a head tracking system, or a variety of available switch accessories.

The device does not incorporate in any way medicinal substances, human blood or plasma derivatives, nor is it manufactured using tissues of animal origin.

## Indications and Contraindications

*Indication:* Accent 800 is a speech generating device that augments communication for an individual with speech/language impairment.

*Contraindication:* This device is not intended to be an emergency call device or sole communication aid.

## Existing Application Risks

No existing application risks are known.

## Expected Service Life

The expected service life of the device, battery charger, and accessories is five years. If you dispose of your device, battery charger, or accessories, please dispose of them in accordance with your local, state, and/or country electronic recycling laws.

## Intended Operators

The individual using the device to communicate, the individual's communication partner, and/or the person changing device settings, maintaining software files, etc. are the intended operators of the device.

## Expected Position of Operators

In normal use, the device is expected to be within 12 to 14 inches of the individual's body. The distance will vary according to whether the device is hand-held or mounted on a wheelchair or table. If the device is used with an eye tracking module or head tracking module, the distance will be greater.

## Special Skills, Training, or Knowledge Required

No special skills or training are required to operate or maintain the device. The pictures and text in this document will help the operators acquire the knowledge to achieve the intended use of the device.

## Instructions for Use

- All functions of the device are safe for use by the user. For best results, follow the instructions in this manual.
- There is no need to turn the device or amplifier off when using the device on a daily basis. It is recommended to restart the device once per week and put it to sleep daily.
- To report any serious incident associated with the device, contact PRC-Salttillo and your national authority.
- For information on cleaning the device, see "Cleaning and Disinfecting the Device".

## Contact Information for Assistance

If you need assistance in setting up, using, or maintaining your device or if you need to report unexpected operation or an unexpected event related to the device, please contact PRC technical support by phone at 1-800-262-1990 or by email at [service@prentrom.com](mailto:service@prentrom.com).

## Instructions for Storage









If you will be leaving the device in storage for a long period of time, turn the device off. Devices in storage must be charged every six months.

## Integrated Feature Pack (IFP)











Most funding sources require that an Accent device be shipped as a dedicated communication device. This means that access to some of the extended features is limited. To use all extended features, the device needs to be unlocked by purchasing an Integrated Feature Pack (IFP). For more information on purchasing an IFP, contact Sales at (800) 262-1933 or [sales@prentrom.com](mailto:sales@prentrom.com).

## Explanation of Symbols

This section explains the symbols that appear on Accent 800 devices, accessories, or packaging.

| Symbol  | Explanation  |
|---|--|
|  | The device is Federal Communications Commission (FCC)-compliant.   |
|  | The device conforms to European Union health, safety, and environmental standards.   |
|  | The device conforms to the requirements of the UK MDR 2002.  |
|  | The entire device, excluding the adapter and signal input/output ports, is a type BF applied part. "Applied part" refers to the part of the device with which the user comes into physical contact when using it for its intended function.  |
|  | The device complies with applicable ACMA technical standards for telecommunications, radiocommunications, EMC, and EME.  |
|  | Caution is necessary when using the device close to where the symbol is placed to avoid undesirable consequences.  |
|  | The device emits generally elevated, potentially hazardous, levels of non-ionizing electromagnetic radiation.  |
|  | Recycle electronic equipment. Do not throw the device in the trash.  |
| <b>IP22</b>   | The device is protected against solid foreign objects of 12.5 mm or greater and vertically falling water drops when tilted up to 15°.  |
|  | <p>The range of temperatures to which the device can be exposed while in use is 0° to 40°C (32° to 104°F). While in storage or during transport, the range of temperatures to which the device can be exposed is -20° to 60°C (-4° to 140°F). See also "Temperature Conditions for Direct Contact" below.</p> <p><i>Caution:</i> If the device has been stored in an environment in which the temperature range is different from "the range of temperatures to which the device can be exposed while in use", let the device stand for at least 30 minutes before using it.</p> |



| Symbol  | Explanation  |
|---|--|
|  | The range of humidity to which the device can be exposed while in use or in storage is 10% to 90%. |
|  | Atmospheric pressure while in use, in storage, or during transport is 80 kPa to 106 kPa.           |
|  | Follow the instructions for use. Refer to the instruction manual.                                  |
|  | Consult the instructions for use   |
|  | The device model number.   |
|  | The device serial number.  |
|  | The name and address of the manufacturer of the device.  |
|  | Indicates a medical device.  |
|  | The authorized representative in the European Community.   |
|  | The responsible person in the United Kingdom.  |

## Charger

The following charger is compatible with the device: Megmeet MANGO60S-18BB-PRC (available from PRC). Only use this charger to charge the device.

## Classifications

|   |                               |
|---|-------------------------------|
| <b>Protection against electrical shock</b>                                | Class II / internally powered |
| <b>Protection against harmful ingress of water and particulate matter</b> | IP22                          |
| <b>Mode of operation</b>  | Continuous                    |
| <b>Type of applied part</b>   | BF                            |

## Specifications

|                            |  |
|----------------------------|--|
| <b>Weight</b>              | 2.5 lbs.   |
| <b>Dimensions</b>          | 9 in. x 5.9 in. X 1.5 in.  |
| <b>Display</b>             | 8 in. diagonally, screen resolution 1920 x 1200 dpi with LCD IPS   |
| <b>Battery life</b>        | Ranges from 8 to 9 hours depending on individual usage and power settings  |
| <b>Memory</b>              | 8 GB   |
| <b>Storage</b>             | 256 GB   |
| <b>Processor</b>           | Intel Celeron N4500  |
| <b>Operating system</b>    | Microsoft® Windows® 11 Pro   |
| <b>Standard components</b> | Frame, handle, stand, battery charger, USB flash drive, stylus   |
| <b>Accessories</b>         | Carry case, standard and deluxe carry straps, screen protectors, external power pack, QRM mounting plate, device mounting brackets, keyguards, TouchGuides, replacement frame, an extra rugged Xtreme™ case, NuPoint® head tracking module |

## Operating Environment

|  |                             |
|--|-----------------------------|
| <b>Ambient temperature</b>                                 | 0°C to 40°C (32°F to 104°F) |
| <b>Relative humidity</b>                                   | 10% to 90%                  |
| <b>Atmospheric pressure</b>                                | 80 kPa to 106 kPa           |
| The device needs to be protected from moisture during use. |                             |

## Transport and Storage Environment

While in transport or storage, the range of temperatures to which the device can be exposed is -20°C to 60°C (-4°F to 140°F), with an atmospheric pressure range of 80 kPa to 106 kPa.

## Temperature Conditions for Direct Contact

### Conditions for Safe Contact – Time

| <b>Accessible Part</b>      | <b>Contact Time Limit</b> |
|-----------------------------|---------------------------|
| Touchscreen                 | Less than 10 minutes      |
| Plastic enclosure of device | Less than 10 minutes      |
| Button                      | Less than 10 minutes      |

### Conditions for Safe Contact – Temperature

| <b>Accessible Part</b>      | <b>Maximum Temperature while Device is in use (ambient temperature 40°C or 104°F)</b> |
|-----------------------------|---|
| Touchscreen                 | 46.1°C (114.98°F)   |
| Plastic enclosure of device | 47.0°C (116.60°F)   |
| Button                      | 42.3°C (108.14°F)   |

- ⚠ While the device is charging, touching the surface of the device with broken skin may aggravate a wound.
- ⚠ While the device is charging, infants or high-risk groups should not touch the surface of the device if there is a chance of burning the skin.